



K PUSH

K PUSH

K PUSH is the new automatic opening system for doors without handles or knobs.

A special inner mechanism provides a very silent, yet powerful utilization, granting a long durability which makes it perfectly suitable for a wide range of doors.

The captivating design and the minimal shape make K PUSH aesthetically unique.

Moreover K PUSH is available in 2 versions:

- with buffer for cabinets using sprung hinges.
- with magnet for cabinets using unsprung hinges or negative hinges.

Available for installation through adapter housing with countersunk holes for screws and inside the panel.



Engineering plastic and steel

In accordance with the Italian regulation UNI 8607/05 Level 5

REGISTERED DESIGN

K PUSH INSTALLATION THROUGH ADAPTER HOUSING

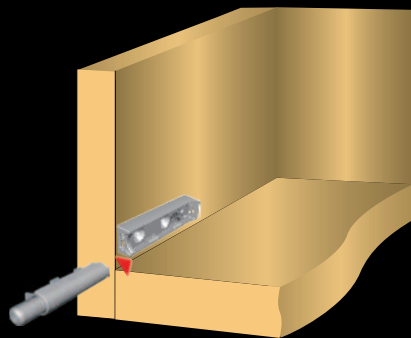

WITH MAGNET
for cabinets using unsprung hinges
or negative hinges

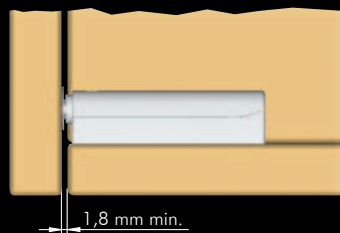

WITH BUFFER
for cabinets using sprung hinges

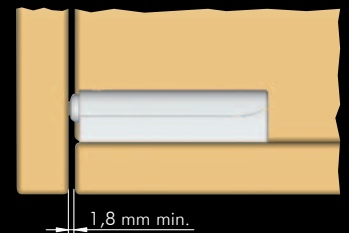

ADJUSTMENTS

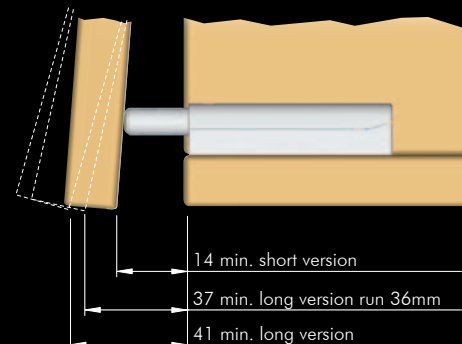
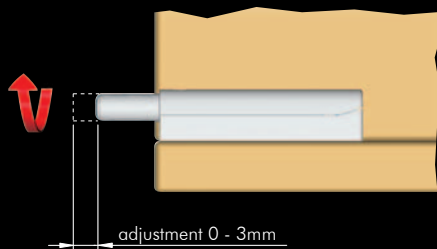

K PUSH INSTALLATION TO BE EMBEDDED INSIDE THE PANEL

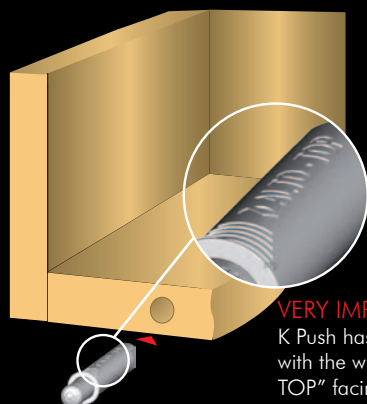

VERY IMPORTANT
K Push has to be installed
with the writing "ALTO -
TOP" facing upwards.

WITH MAGNET
for cabinets using unsprung hinges
or negative hinges

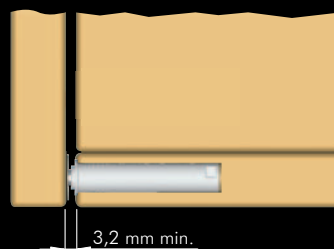

WITH BUFFER
for cabinets using sprung hinges

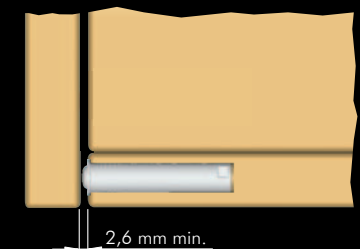

ADJUSTMENTS

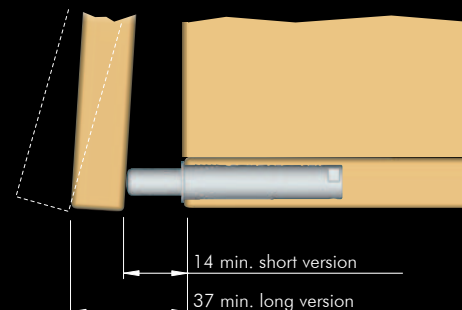
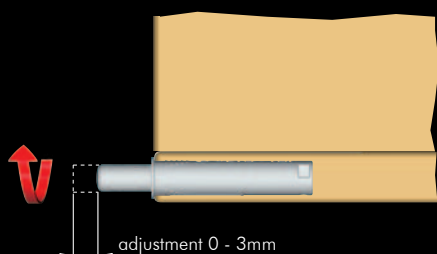

K PUSH SCREW FIXING THE SHORT WITH ADAPTER HOUSING

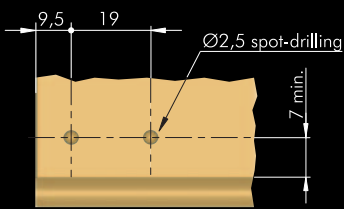

Fixing with Ø3x16mm countersunk wood screw.

	Part. no	Finish
K Push the short with buffer	55105010IJ	Grey
K Push the short with magnet	55005010IJ	Grey

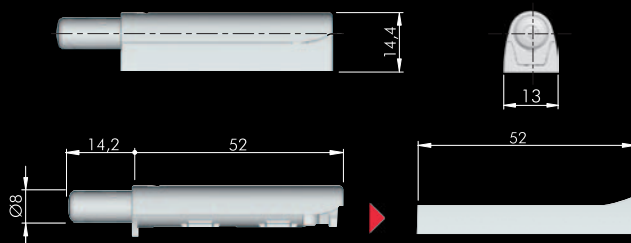

	Part. no	Finish
adapter housing	55006010IJ	Grey

Other finishes already available: black, white. Please ask for related part.no

K PUSH SCREW FIXING THE LONG WITH ADAPTER HOUSING

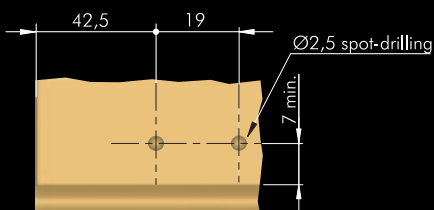

Fixing with Ø3x16mm countersunk wood screw.

	Part. no	Finish
K Push the long with buffer	55107010IJ	Grey
K Push the long with magnet	55109010IJ	Grey



	Part. no	Finish
adapter housing	55006010IJ	Grey

Other finishes already available: black, white. Please ask for related part.no

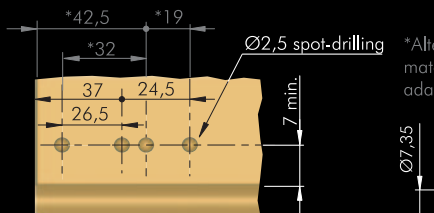

Fixing with Ø3x16mm countersunk wood screw.

*Alternative drilling pattern to match pre-drilled holes for short adapter housings.

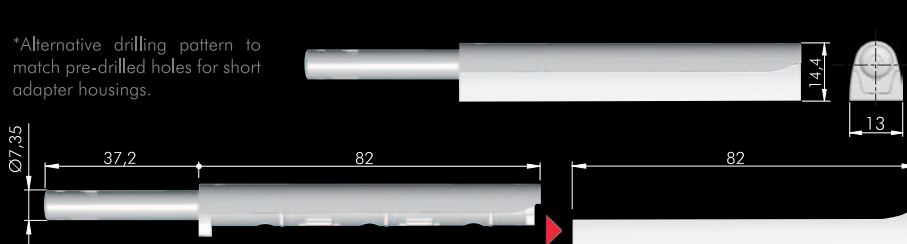

	Part. no	Finish
K Push the long with buffer run 36mm	55112000IJ	Grey
K Push the long with magnet run 36mm	55113000IJ	Grey
K Push the long with buffer run 36mm extra strong spring	55112030IJ	Grey
K Push the long with magnet run 36mm extra strong spring	55113010IJ	Grey

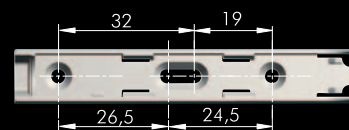

	Part. no	Finish
adapter housing	55112010IJ	Grey

Other finishes already available: black, white. Please ask for related part.no

K PUSH CONCEALED SHORT AND LONG VERSION

	Part. no	Finish
K Push the short concealed with buffer	55104010IJ	Grey
K Push the short concealed with magnet	55004010IJ	Grey
K Push the long concealed with buffer	55110000IJ	Grey
K Push the long concealed with magnet	55111000IJ	Grey
K Push the long concealed with buffer extra strong spring	55110010IJ	Grey
K Push the long concealed with magnet extra strong spring	55111010IJ	Grey

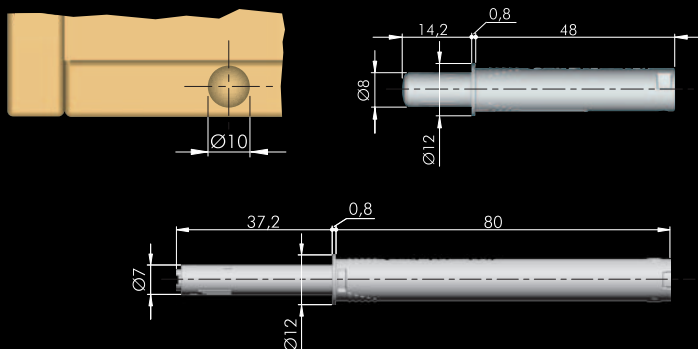

Other finishes already available: black, white. Please ask for related part.no

PLATES FOR K PUSH WITH MAGNET

Self adhesive plate

Part. no
55006020XD

Ø3mm pin

Part. no
55006030YA

Ø5mm pin

Part. no
55006040YA

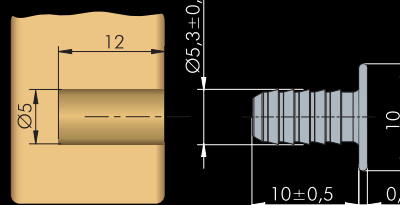
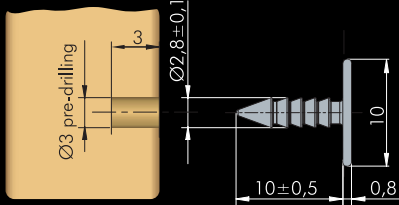
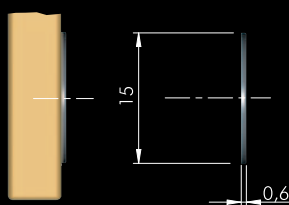

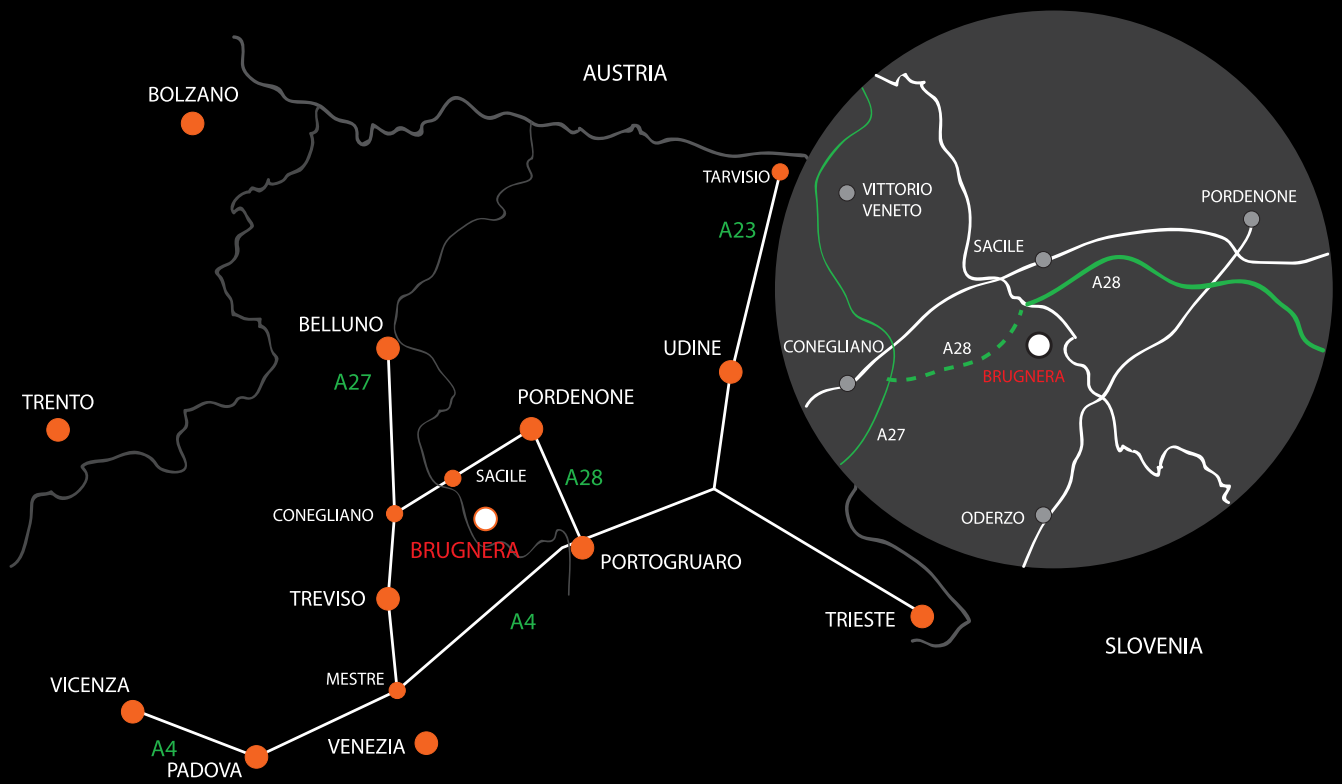

ITALIANA FERRAMENTA

via Taglio n° 87 I - 33070 Maron di Brugnera (PN) Tel. +39 0434 428211 Fax +39 0434 428242 www.italianaferramenta.it info@italianaferramenta.it